

■ システム系統図

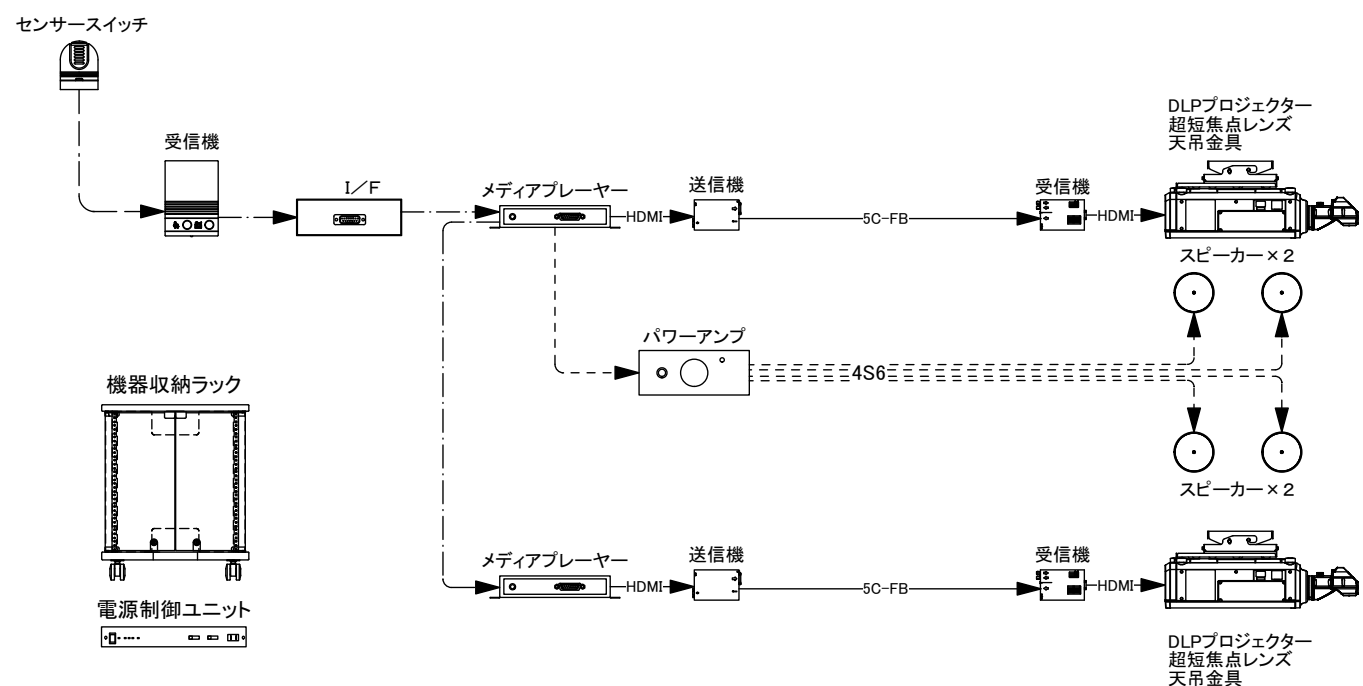

■ 使用機器一覧

No.	品名	仕様	メーカー及び型番	台数
1	センサースイッチ	熱線レベル変化分検知方式	パナソニック電気 EL230491	1式
2	メディアプレーヤー	対応ビデオコンテナ: Full HD 対応拡張子: .ts, .mpg, .vob, .mov, .mp4, .m2ts, .wmv	BrightSign HD224	2台
3	SDXCカード	microSDXCカード class10 16GB 予備含む	Sandisk 16GB	4枚
4	送信機	HDCP対応 最大110m延長可能(5C-FB使用時)	イメージクス CRO-DCE15ATX	2台
5	受信機	フレームシンクロナイザー内蔵型	イメージクス CRO-RS22A	2台
6	DLPプロジェクター	光源:レーザー 解像度:1920×1200 明るさ:6000ANSIルーメン	Panasonic PT-RZ660JLB	2台
7	レンズ	F値:2.0 f=5.3mm	Panasonic ET-DLE035	2本
8	ベース金具	天吊金具とプロジェクター本体の連結金具	Panasonic ET-PKD130B	2台
9	天吊金具	低天井用	Panasonic ET-PKD120S	2台
10	パワーアンプ	最大出力:15W+15W	Fostex Ap15d	1台
11	スピーカー	インピーダンス:8Ω 許容入力:15W	YAMAHA VXC2FB	4台
12	電源制御ユニット	カットリレー機能付き	RAMSA WU-L67	1台
13	機器収納ラック	EIA規格 12U収納可能	オーロラ EIA-K12B	1台
14	L/F	センサー入力管理 メディアプレーヤーの制御	特注品	1台

※ 機器に関しては、同等品以上とする。

■ 機器図

1	センサースイッチ	1台	2	メディアプレーヤー	2台	3	SDXCカード	4枚	4	送信機	2台	5	受信機	2台	6	DLPプロジェクター	2台	7	レンズ	2本																																																																																																																																																			
<table border="1"> <tr><td>メーカー</td><td>パナソニック電気</td></tr> <tr><td>型番</td><td>EL230491</td></tr> <tr><td>外形寸法</td><td>φ60×D77 mm(検知部)</td></tr> <tr><td>消費電力</td><td>6W(受信部)</td></tr> <tr><td>重量</td><td>30g(検知部)</td></tr> </table>		メーカー	パナソニック電気	型番	EL230491	外形寸法	φ60×D77 mm(検知部)	消費電力	6W(受信部)	重量	30g(検知部)	<p>平成31年度納品済み</p> <table border="1"> <tr><td>メーカー</td><td>BrightSign</td></tr> <tr><td>型番</td><td>HD224</td></tr> <tr><td>外形寸法</td><td>W159.9×H22×D144 mm</td></tr> <tr><td>消費電力</td><td>12V/1.5A</td></tr> <tr><td>重量</td><td>1.0g</td></tr> </table>		メーカー	BrightSign	型番	HD224	外形寸法	W159.9×H22×D144 mm	消費電力	12V/1.5A	重量	1.0g	<table border="1"> <tr><td>メーカー</td><td>Sandisk</td></tr> <tr><td>型番</td><td>16GB</td></tr> <tr><td>外形寸法</td><td>W15×H11×t1 mm</td></tr> <tr><td>消費電力</td><td>- w</td></tr> <tr><td>重量</td><td>1g</td></tr> </table>		メーカー	Sandisk	型番	16GB	外形寸法	W15×H11×t1 mm	消費電力	- w	重量	1g	<p>平成31年度納品済み</p> <table border="1"> <tr><td>メーカー</td><td>イメージクス</td></tr> <tr><td>型番</td><td>CRO-DCE15ATX</td></tr> <tr><td>外形寸法</td><td>W100×H25×D150 mm</td></tr> <tr><td>消費電力</td><td>5W</td></tr> <tr><td>重量</td><td>500g</td></tr> </table>		メーカー	イメージクス	型番	CRO-DCE15ATX	外形寸法	W100×H25×D150 mm	消費電力	5W	重量	500g	<p>平成31年度納品済み</p> <table border="1"> <tr><td>メーカー</td><td>イメージクス</td></tr> <tr><td>型番</td><td>CRO-RS22A</td></tr> <tr><td>外形寸法</td><td>W100×H25×D150 mm</td></tr> <tr><td>消費電力</td><td>6W</td></tr> <tr><td>重量</td><td>550g</td></tr> </table>		メーカー	イメージクス	型番	CRO-RS22A	外形寸法	W100×H25×D150 mm	消費電力	6W	重量	550g	<p>平成31年度納品済み</p> <table border="1"> <tr><td>メーカー</td><td>Panasonic</td></tr> <tr><td>型番</td><td>PT-RZ660JLB</td></tr> <tr><td>外形寸法</td><td>W498×H200×D538 mm</td></tr> <tr><td>消費電力</td><td>700W</td></tr> <tr><td>重量</td><td>22.3kg</td></tr> </table>		メーカー	Panasonic	型番	PT-RZ660JLB	外形寸法	W498×H200×D538 mm	消費電力	700W	重量	22.3kg	<p>平成31年度納品済み</p> <table border="1"> <tr><td>メーカー</td><td>Panasonic</td></tr> <tr><td>型番</td><td>ET-DLE035</td></tr> <tr><td>外形寸法</td><td>W132×H102×D311 mm</td></tr> <tr><td>消費電力</td><td>- W</td></tr> <tr><td>重量</td><td>1.3kg</td></tr> </table>		メーカー	Panasonic	型番	ET-DLE035	外形寸法	W132×H102×D311 mm	消費電力	- W	重量	1.3kg	<p>平成31年度納品済み</p> <table border="1"> <tr><td>メーカー</td><td>Panasonic</td></tr> <tr><td>型番</td><td>ET-PKD130B</td></tr> <tr><td>外形寸法</td><td>W379×H56×D400 mm</td></tr> <tr><td>消費電力</td><td>- W</td></tr> <tr><td>重量</td><td>3.0kg</td></tr> </table>		メーカー	Panasonic	型番	ET-PKD130B	外形寸法	W379×H56×D400 mm	消費電力	- W	重量	3.0kg	<p>平成31年度納品済み</p> <table border="1"> <tr><td>メーカー</td><td>Panasonic</td></tr> <tr><td>型番</td><td>ET-PKD120S</td></tr> <tr><td>外形寸法</td><td>W258×H80×D286 mm</td></tr> <tr><td>消費電力</td><td>- W</td></tr> <tr><td>重量</td><td>3.0kg</td></tr> </table>		メーカー	Panasonic	型番	ET-PKD120S	外形寸法	W258×H80×D286 mm	消費電力	- W	重量	3.0kg	<table border="1"> <tr><td>メーカー</td><td>Fostex</td></tr> <tr><td>型番</td><td>Ap15d</td></tr> <tr><td>外形寸法</td><td>W110×H30×D75 mm</td></tr> <tr><td>消費電力</td><td>45W</td></tr> <tr><td>重量</td><td>250g</td></tr> </table>		メーカー	Fostex	型番	Ap15d	外形寸法	W110×H30×D75 mm	消費電力	45W	重量	250g	<table border="1"> <tr><td>メーカー</td><td>YAMAHA</td></tr> <tr><td>型番</td><td>VXC2FB</td></tr> <tr><td>外形寸法</td><td>Φ225×D89 mm</td></tr> <tr><td>消費電力</td><td>- W</td></tr> <tr><td>重量</td><td>1.7kg</td></tr> </table>		メーカー	YAMAHA	型番	VXC2FB	外形寸法	Φ225×D89 mm	消費電力	- W	重量	1.7kg	<table border="1"> <tr><td>メーカー</td><td>RAMSA</td></tr> <tr><td>型番</td><td>WU-L67</td></tr> <tr><td>外形寸法</td><td>W480×H44×D300 mm</td></tr> <tr><td>消費電力</td><td>10W</td></tr> <tr><td>重量</td><td>4.0kg</td></tr> </table>		メーカー	RAMSA	型番	WU-L67	外形寸法	W480×H44×D300 mm	消費電力	10W	重量	4.0kg	<table border="1"> <tr><td>メーカー</td><td>オーロラ</td></tr> <tr><td>型番</td><td>EIA-K12B</td></tr> <tr><td>外形寸法</td><td>W564×H672×D546 mm</td></tr> <tr><td>消費電力</td><td>- W</td></tr> <tr><td>重量</td><td>21.0kg</td></tr> </table>		メーカー	オーロラ	型番	EIA-K12B	外形寸法	W564×H672×D546 mm	消費電力	- W	重量	21.0kg	<table border="1"> <tr><td>メーカー</td><td>特注品</td></tr> <tr><td>型番</td><td></td></tr> <tr><td>外形寸法</td><td>W130×H45×D180 mm</td></tr> <tr><td>消費電力</td><td>100W</td></tr> <tr><td>重量</td><td>700g</td></tr> </table>		メーカー	特注品	型番		外形寸法	W130×H45×D180 mm	消費電力	100W	重量	700g
メーカー	パナソニック電気																																																																																																																																																																						
型番	EL230491																																																																																																																																																																						
外形寸法	φ60×D77 mm(検知部)																																																																																																																																																																						
消費電力	6W(受信部)																																																																																																																																																																						
重量	30g(検知部)																																																																																																																																																																						
メーカー	BrightSign																																																																																																																																																																						
型番	HD224																																																																																																																																																																						
外形寸法	W159.9×H22×D144 mm																																																																																																																																																																						
消費電力	12V/1.5A																																																																																																																																																																						
重量	1.0g																																																																																																																																																																						
メーカー	Sandisk																																																																																																																																																																						
型番	16GB																																																																																																																																																																						
外形寸法	W15×H11×t1 mm																																																																																																																																																																						
消費電力	- w																																																																																																																																																																						
重量	1g																																																																																																																																																																						
メーカー	イメージクス																																																																																																																																																																						
型番	CRO-DCE15ATX																																																																																																																																																																						
外形寸法	W100×H25×D150 mm																																																																																																																																																																						
消費電力	5W																																																																																																																																																																						
重量	500g																																																																																																																																																																						
メーカー	イメージクス																																																																																																																																																																						
型番	CRO-RS22A																																																																																																																																																																						
外形寸法	W100×H25×D150 mm																																																																																																																																																																						
消費電力	6W																																																																																																																																																																						
重量	550g																																																																																																																																																																						
メーカー	Panasonic																																																																																																																																																																						
型番	PT-RZ660JLB																																																																																																																																																																						
外形寸法	W498×H200×D538 mm																																																																																																																																																																						
消費電力	700W																																																																																																																																																																						
重量	22.3kg																																																																																																																																																																						
メーカー	Panasonic																																																																																																																																																																						
型番	ET-DLE035																																																																																																																																																																						
外形寸法	W132×H102×D311 mm																																																																																																																																																																						
消費電力	- W																																																																																																																																																																						
重量	1.3kg																																																																																																																																																																						
<p>平成31年度納品済み</p> <table border="1"> <tr><td>メーカー</td><td>Panasonic</td></tr> <tr><td>型番</td><td>ET-PKD130B</td></tr> <tr><td>外形寸法</td><td>W379×H56×D400 mm</td></tr> <tr><td>消費電力</td><td>- W</td></tr> <tr><td>重量</td><td>3.0kg</td></tr> </table>		メーカー	Panasonic	型番	ET-PKD130B	外形寸法	W379×H56×D400 mm	消費電力	- W	重量	3.0kg	<p>平成31年度納品済み</p> <table border="1"> <tr><td>メーカー</td><td>Panasonic</td></tr> <tr><td>型番</td><td>ET-PKD120S</td></tr> <tr><td>外形寸法</td><td>W258×H80×D286 mm</td></tr> <tr><td>消費電力</td><td>- W</td></tr> <tr><td>重量</td><td>3.0kg</td></tr> </table>		メーカー	Panasonic	型番	ET-PKD120S	外形寸法	W258×H80×D286 mm	消費電力	- W	重量	3.0kg	<table border="1"> <tr><td>メーカー</td><td>Fostex</td></tr> <tr><td>型番</td><td>Ap15d</td></tr> <tr><td>外形寸法</td><td>W110×H30×D75 mm</td></tr> <tr><td>消費電力</td><td>45W</td></tr> <tr><td>重量</td><td>250g</td></tr> </table>		メーカー	Fostex	型番	Ap15d	外形寸法	W110×H30×D75 mm	消費電力	45W	重量	250g	<table border="1"> <tr><td>メーカー</td><td>YAMAHA</td></tr> <tr><td>型番</td><td>VXC2FB</td></tr> <tr><td>外形寸法</td><td>Φ225×D89 mm</td></tr> <tr><td>消費電力</td><td>- W</td></tr> <tr><td>重量</td><td>1.7kg</td></tr> </table>		メーカー	YAMAHA	型番	VXC2FB	外形寸法	Φ225×D89 mm	消費電力	- W	重量	1.7kg	<table border="1"> <tr><td>メーカー</td><td>RAMSA</td></tr> <tr><td>型番</td><td>WU-L67</td></tr> <tr><td>外形寸法</td><td>W480×H44×D300 mm</td></tr> <tr><td>消費電力</td><td>10W</td></tr> <tr><td>重量</td><td>4.0kg</td></tr> </table>		メーカー	RAMSA	型番	WU-L67	外形寸法	W480×H44×D300 mm	消費電力	10W	重量	4.0kg	<table border="1"> <tr><td>メーカー</td><td>オーロラ</td></tr> <tr><td>型番</td><td>EIA-K12B</td></tr> <tr><td>外形寸法</td><td>W564×H672×D546 mm</td></tr> <tr><td>消費電力</td><td>- W</td></tr> <tr><td>重量</td><td>21.0kg</td></tr> </table>		メーカー	オーロラ	型番	EIA-K12B	外形寸法	W564×H672×D546 mm	消費電力	- W	重量	21.0kg	<table border="1"> <tr><td>メーカー</td><td>特注品</td></tr> <tr><td>型番</td><td></td></tr> <tr><td>外形寸法</td><td>W130×H45×D180 mm</td></tr> <tr><td>消費電力</td><td>100W</td></tr> <tr><td>重量</td><td>700g</td></tr> </table>		メーカー	特注品	型番		外形寸法	W130×H45×D180 mm	消費電力	100W	重量	700g																																																																																				
メーカー	Panasonic																																																																																																																																																																						
型番	ET-PKD130B																																																																																																																																																																						
外形寸法	W379×H56×D400 mm																																																																																																																																																																						
消費電力	- W																																																																																																																																																																						
重量	3.0kg																																																																																																																																																																						
メーカー	Panasonic																																																																																																																																																																						
型番	ET-PKD120S																																																																																																																																																																						
外形寸法	W258×H80×D286 mm																																																																																																																																																																						
消費電力	- W																																																																																																																																																																						
重量	3.0kg																																																																																																																																																																						
メーカー	Fostex																																																																																																																																																																						
型番	Ap15d																																																																																																																																																																						
外形寸法	W110×H30×D75 mm																																																																																																																																																																						
消費電力	45W																																																																																																																																																																						
重量	250g																																																																																																																																																																						
メーカー	YAMAHA																																																																																																																																																																						
型番	VXC2FB																																																																																																																																																																						
外形寸法	Φ225×D89 mm																																																																																																																																																																						
消費電力	- W																																																																																																																																																																						
重量	1.7kg																																																																																																																																																																						
メーカー	RAMSA																																																																																																																																																																						
型番	WU-L67																																																																																																																																																																						
外形寸法	W480×H44×D300 mm																																																																																																																																																																						
消費電力	10W																																																																																																																																																																						
重量	4.0kg																																																																																																																																																																						
メーカー	オーロラ																																																																																																																																																																						
型番	EIA-K12B																																																																																																																																																																						
外形寸法	W564×H672×D546 mm																																																																																																																																																																						
消費電力	- W																																																																																																																																																																						
重量	21.0kg																																																																																																																																																																						
メーカー	特注品																																																																																																																																																																						
型番																																																																																																																																																																							
外形寸法	W130×H45×D180 mm																																																																																																																																																																						
消費電力	100W																																																																																																																																																																						
重量	700g																																																																																																																																																																						

MEMO

勝連城址周辺整備事業 歴史文化施設展示制作業務

REVISION



TITLE

1-1.おもしろさうしと阿麻和利の物語

SUBJECTS

システム系統図

No.

AV01-1

DRAWN

DESIGNED

CHECKED

DATE

2020.12.16改訂

SCALE

NON

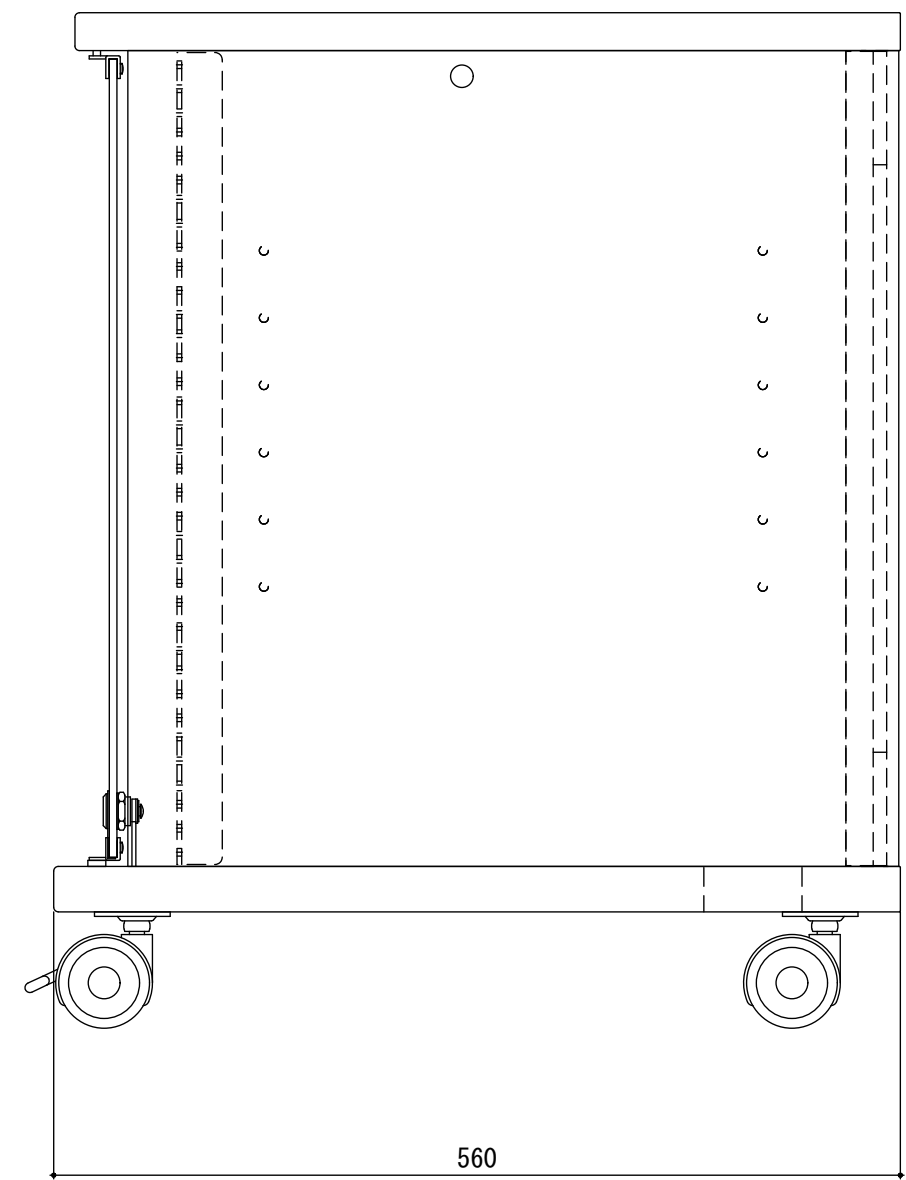
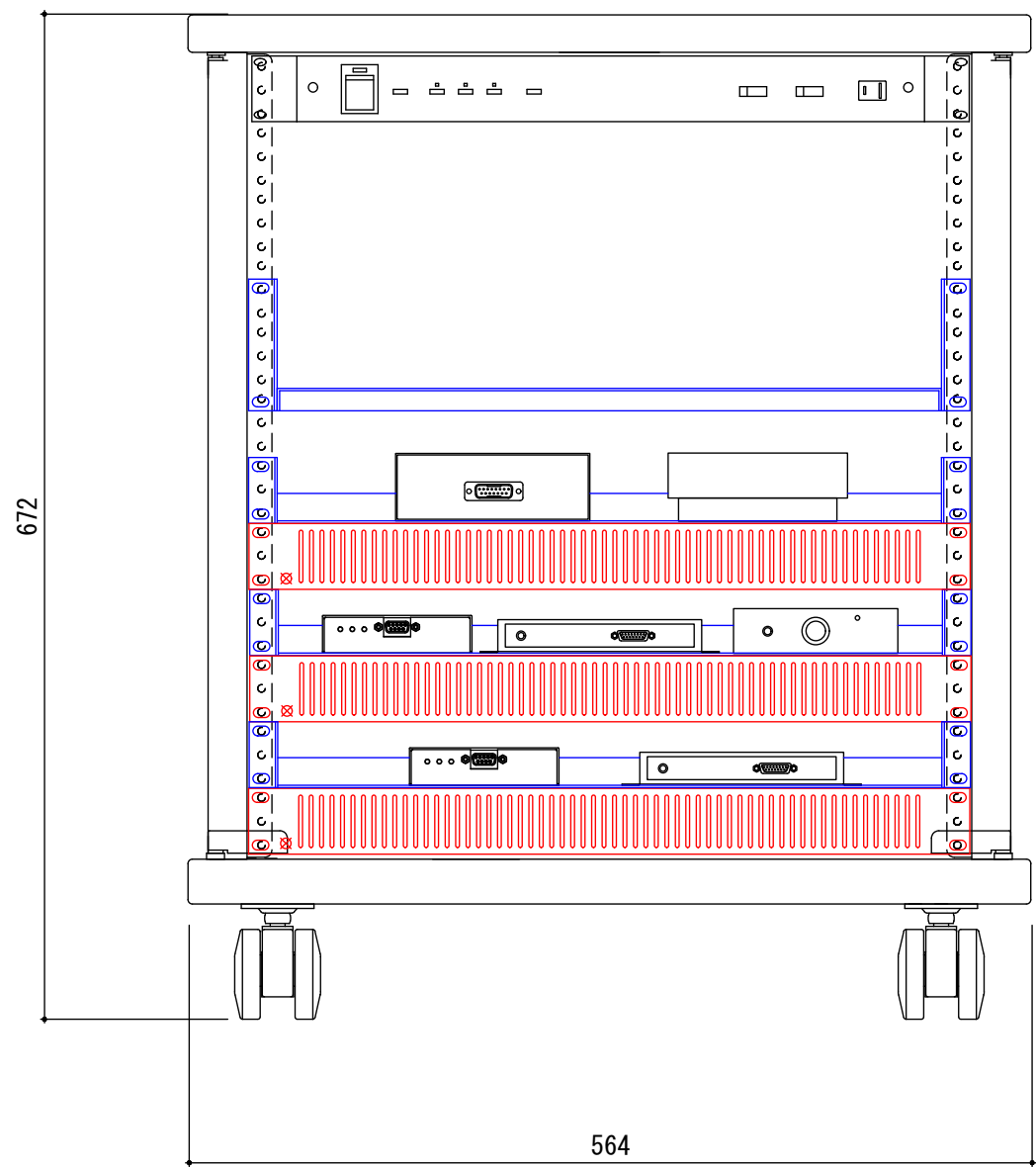

MEMO

勝連城址周辺整備事業 歴史文化施設展示制作業務

REVISION



TITLE

1-1.おもろさうしと阿麻和利の物語

SUBJECTS

ラック搭載図

No.

AV01-2

DRAWN

DESIGNED

CHECKED

DATE

2020.12.16改訂

SCALE

1/5(A3出力時)

■ システム系統図

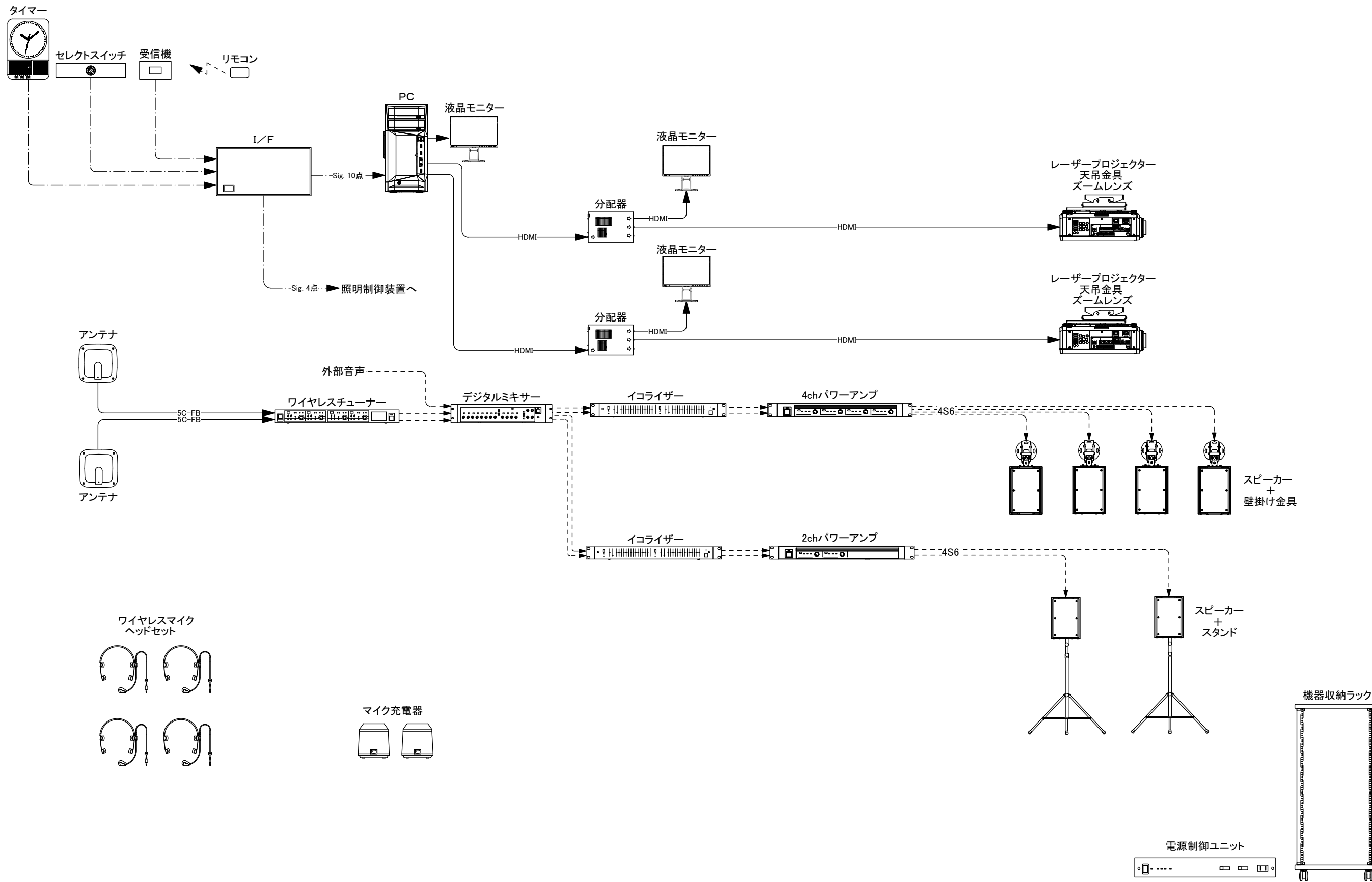

MEMO

勝連城址周辺整備事業 歴史文化施設展示制作業務

REVISION



TITLE

3.肝高ライブステージ

SUBJECTS

システム系統図

No.

AV02-1

DRAWN

DESIGNED

CHECKED

DATE

2020.12.16改訂











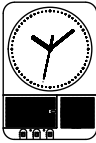
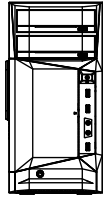
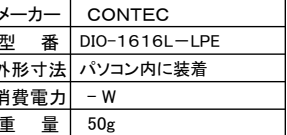
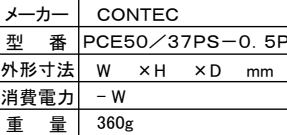

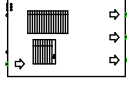

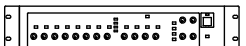
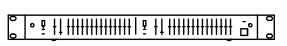

SCALE

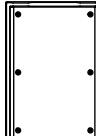
NON

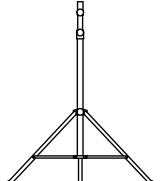
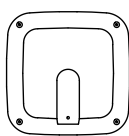
■ 使用機器一覧

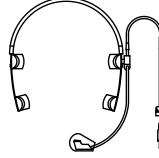
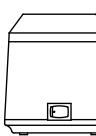
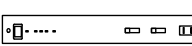
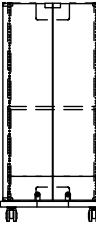
No.	品名	仕様	メーカー及び型番	台数
1	タイマー	停電補償:800時間以上 プログラム数:120プログラム	パナソニック電工 TDW73	1台
2	PC	CPU:インテルCore™i7-9700(3.6GHz) メモリ:32GB SSD:516GB OS:Windows10 IoT Enterprise 2019 LTSC	EPSON JM8200	1台
3	入出力ボード	入力16点出力16点	CONTEC DIO-1616L-LPE	1枚
4	専用ケーブル	50ピンミニチュアリボン→39ピンD-sub変換ケーブル	CONTEC PCE50/37PS-0.5P	1本
5	液晶モニター	22.5インチ 視野角:上下左右178° / 178°	EIZO EV2360	3台
6	分配器	HDMI 1入力3分配	イメージニクス CRO-HD13	2台
7	DLPプロジェクター	光源:レーザー 解像度:1920×1200 明るさ:8500ANSIルーメン	Panasonic PT--RZ870JLB	2台
8	レンズ	F値:1.7~1.9 f=25.6~35.7mm	Panasonic ET-DLE170	2本
9	ベース金具	天吊金具とプロジェクター本体の連結金具	Panasonic ET-PKD130B	2台
10	天吊金具	低天井用	Panasonic ET-PKD120S	2台
11	デジタルミキサー	入力:モノラル8系統ステレオ4系統 出力:メイン2系統 モノラル2系統	Panasonic WR-DX002	1台
12	イコライザー	2/3オクターブ14ポイント調節可能 2チャンネル搭載	TOA E-232	2台
13	パワーアンプ	120W×4(8Ω負荷時)	Panasonic WP-DA204	1台
14	パワーアンプ	120W×2(8Ω負荷時)	Panasonic WP-DA202	1台
15	スピーカー	インピーダンス:8Ω 定格入力:130W	Panasonic WS-AR080-K	6台
16	スピーカー金具	壁掛けタイプ	Panasonic WS-Q149-K	4台
17	スピーカースタンド	アルミ製	K&M 21450B	2台
18	アンテナ	受信周波数:806~810MHz	TOA YW-560	2台
19	ワイヤレスチューナー	800MHz帯 4ch	TOA WT-D1804	1台
20	ワイヤレスマイク	水晶制御PLLシンセサイザー方式	TOA WM-D1300	4台
21	ヘッドセット	指向性:単一指向性	TOA WH-1000	4台
22	マイク充電器	充電台数:2台 充電時間:最大3時間	TOA BC-2000	2台
23	リモコン	4キー 2.4GHz帯無線	ダイセン電子工業 TC04ZBTM	3台
24	受信機	2.4GHz帯無線外部受信機	ダイセン電子工業 TC04ZBTM-C-RU	1台
25	電源制御装置	カットオフリレー端子付き	RAMSA WU-L67	1台
26	機器収納ラック	EIA規格 最大24U収納可能	オーロラ EIA-K24B	1台
27	セレクトスイッチ	番組選択用	特注品	1式
28	I/F	全体演出制御	特注品	1台

※ 機器に関しては、同等品以上とする。

1	タイマー	1台	2	PC	1台	3	入出力ボード	1枚	4	専用ケーブル	1本	5	液晶モニター	3台	6	分配器	2台	7	DLPプロジェクター	2台	8	レンズ	2本																																																																								
																																																																																															
<table border="1"> <tr><td>メーカー</td><td>パナソニック電工</td></tr> <tr><td>型番</td><td>TDW73</td></tr> <tr><td>外形寸法</td><td>W280×H410×D60mm</td></tr> <tr><td>消費電力</td><td>10W</td></tr> <tr><td>重量</td><td>600g</td></tr> </table>		メーカー	パナソニック電工	型番	TDW73	外形寸法	W280×H410×D60mm	消費電力	10W	重量	600g	<table border="1"> <tr><td>メーカー</td><td>EPSON</td></tr> <tr><td>型番</td><td>JM8200</td></tr> <tr><td>外形寸法</td><td>W180×H368×D405 mm</td></tr> <tr><td>消費電力</td><td>650W</td></tr> <tr><td>重量</td><td>10.3kg</td></tr> </table>		メーカー	EPSON	型番	JM8200	外形寸法	W180×H368×D405 mm	消費電力	650W	重量	10.3kg	<table border="1"> <tr><td>メーカー</td><td>CONTEC</td></tr> <tr><td>型番</td><td>DIO-1616L-LPE</td></tr> <tr><td>外形寸法</td><td>パソコン内に装着</td></tr> <tr><td>消費電力</td><td>-W</td></tr> <tr><td>重量</td><td>50g</td></tr> </table>		メーカー	CONTEC	型番	DIO-1616L-LPE	外形寸法	パソコン内に装着	消費電力	-W	重量	50g	<table border="1"> <tr><td>メーカー</td><td>CONTEC</td></tr> <tr><td>型番</td><td>PCE50/37PS-0.5P</td></tr> <tr><td>外形寸法</td><td>W × H × D mm</td></tr> <tr><td>消費電力</td><td>-W</td></tr> <tr><td>重量</td><td>360g</td></tr> </table>		メーカー	CONTEC	型番	PCE50/37PS-0.5P	外形寸法	W × H × D mm	消費電力	-W	重量	360g	<table border="1"> <tr><td>メーカー</td><td>EIZO</td></tr> <tr><td>型番</td><td>EV2360</td></tr> <tr><td>外形寸法</td><td>W499 × H333.9-473.9 × D233mm</td></tr> <tr><td>消費電力</td><td>37W</td></tr> <tr><td>重量</td><td>5.5kg</td></tr> </table>		メーカー	EIZO	型番	EV2360	外形寸法	W499 × H333.9-473.9 × D233mm	消費電力	37W	重量	5.5kg	<table border="1"> <tr><td>メーカー</td><td>イメージテック</td></tr> <tr><td>型番</td><td>CRO-HD13</td></tr> <tr><td>外形寸法</td><td>W100×H25×D150 mm</td></tr> <tr><td>消費電力</td><td>3W</td></tr> <tr><td>重量</td><td>550g</td></tr> </table>		メーカー	イメージテック	型番	CRO-HD13	外形寸法	W100×H25×D150 mm	消費電力	3W	重量	550g	<p>平成31年度納品済み</p> <table border="1"> <tr><td>メーカー</td><td>Panasonic</td></tr> <tr><td>型番</td><td>PT-RZ870JLB</td></tr> <tr><td>外形寸法</td><td>W498 × H200 × D538 mm</td></tr> <tr><td>消費電力</td><td>950W</td></tr> <tr><td>重量</td><td>22.3kg</td></tr> </table>		メーカー	Panasonic	型番	PT-RZ870JLB	外形寸法	W498 × H200 × D538 mm	消費電力	950W	重量	22.3kg	<table border="1"> <tr><td>メーカー</td><td>Panasonic</td></tr> <tr><td>型番</td><td>ET-DLE170</td></tr> <tr><td>外形寸法</td><td>W95 × H95 × D166 mm</td></tr> <tr><td>消費電力</td><td>-W</td></tr> <tr><td>重量</td><td>900g</td></tr> </table>		メーカー	Panasonic	型番	ET-DLE170	外形寸法	W95 × H95 × D166 mm	消費電力	-W	重量	900g
メーカー	パナソニック電工																																																																																														
型番	TDW73																																																																																														
外形寸法	W280×H410×D60mm																																																																																														
消費電力	10W																																																																																														
重量	600g																																																																																														
メーカー	EPSON																																																																																														
型番	JM8200																																																																																														
外形寸法	W180×H368×D405 mm																																																																																														
消費電力	650W																																																																																														
重量	10.3kg																																																																																														
メーカー	CONTEC																																																																																														
型番	DIO-1616L-LPE																																																																																														
外形寸法	パソコン内に装着																																																																																														
消費電力	-W																																																																																														
重量	50g																																																																																														
メーカー	CONTEC																																																																																														
型番	PCE50/37PS-0.5P																																																																																														
外形寸法	W × H × D mm																																																																																														
消費電力	-W																																																																																														
重量	360g																																																																																														
メーカー	EIZO																																																																																														
型番	EV2360																																																																																														
外形寸法	W499 × H333.9-473.9 × D233mm																																																																																														
消費電力	37W																																																																																														
重量	5.5kg																																																																																														
メーカー	イメージテック																																																																																														
型番	CRO-HD13																																																																																														
外形寸法	W100×H25×D150 mm																																																																																														
消費電力	3W																																																																																														
重量	550g																																																																																														
メーカー	Panasonic																																																																																														
型番	PT-RZ870JLB																																																																																														
外形寸法	W498 × H200 × D538 mm																																																																																														
消費電力	950W																																																																																														
重量	22.3kg																																																																																														
メーカー	Panasonic																																																																																														
型番	ET-DLE170																																																																																														
外形寸法	W95 × H95 × D166 mm																																																																																														
消費電力	-W																																																																																														
重量	900g																																																																																														
9	ベース金具	2台	10	天吊金具	2台	11	デジタルミキサー	1台	12	イコライザー	2台	13	パワーアンプ	1台	14	パワーアンプ	1台	15	スピーカー	6台	16	スピーカー金具	4台																																																																								
																																																																																															
<table border="1"> <tr><td>メーカー</td><td>Panasonic</td></tr> <tr><td>型番</td><td>ET-PKD130B</td></tr> <tr><td>外形寸法</td><td>W379 × H56 × D400 mm</td></tr> <tr><td>消費電力</td><td>-W</td></tr> <tr><td>重量</td><td>3.0kg</td></tr> </table>		メーカー	Panasonic	型番	ET-PKD130B	外形寸法	W379 × H56 × D400 mm	消費電力	-W	重量	3.0kg	<table border="1"> <tr><td>メーカー</td><td>Panasonic</td></tr> <tr><td>型番</td><td>ET-PKD120S</td></tr> <tr><td>外形寸法</td><td>W258 × H80 × D286 mm</td></tr> <tr><td>消費電力</td><td>-W</td></tr> <tr><td>重量</td><td>3.0kg</td></tr> </table>		メーカー	Panasonic	型番	ET-PKD120S	外形寸法	W258 × H80 × D286 mm	消費電力	-W	重量	3.0kg	<table border="1"> <tr><td>メーカー</td><td>Panasonic</td></tr> <tr><td>型番</td><td>WR-DX002</td></tr> <tr><td>外形寸法</td><td>W480 × H250 × D88mm</td></tr> <tr><td>消費電力</td><td>18W</td></tr> <tr><td>重量</td><td>4.9kg</td></tr> </table>		メーカー	Panasonic	型番	WR-DX002	外形寸法	W480 × H250 × D88mm	消費電力	18W	重量	4.9kg	<table border="1"> <tr><td>メーカー</td><td>TOA</td></tr> <tr><td>型番</td><td>E-232</td></tr> <tr><td>外形寸法</td><td>W483 × H46 × D311mm</td></tr> <tr><td>消費電力</td><td>11W</td></tr> <tr><td>重量</td><td>3.8kg</td></tr> </table>		メーカー	TOA	型番	E-232	外形寸法	W483 × H46 × D311mm	消費電力	11W	重量	3.8kg	<table border="1"> <tr><td>メーカー</td><td>Panasonic</td></tr> <tr><td>型番</td><td>WP-DA204</td></tr> <tr><td>外形寸法</td><td>W480 × H44 × D350 mm</td></tr> <tr><td>消費電力</td><td>600 W</td></tr> <tr><td>重量</td><td>6.0kg</td></tr> </table>		メーカー	Panasonic	型番	WP-DA204	外形寸法	W480 × H44 × D350 mm	消費電力	600 W	重量	6.0kg	<table border="1"> <tr><td>メーカー</td><td>Panasonic</td></tr> <tr><td>型番</td><td>WP-DA202</td></tr> <tr><td>外形寸法</td><td>W480 × H44 × D350 mm</td></tr> <tr><td>消費電力</td><td>300 W</td></tr> <tr><td>重量</td><td>5.0 kg</td></tr> </table>		メーカー	Panasonic	型番	WP-DA202	外形寸法	W480 × H44 × D350 mm	消費電力	300 W	重量	5.0 kg	<table border="1"> <tr><td>メーカー</td><td>Panasonic</td></tr> <tr><td>型番</td><td>WS-ARO80-K</td></tr> <tr><td>外形寸法</td><td>W312 × H455 × D260 mm</td></tr> <tr><td>消費電力</td><td>-W</td></tr> <tr><td>重量</td><td>10.0 kg</td></tr> </table>		メーカー	Panasonic	型番	WS-ARO80-K	外形寸法	W312 × H455 × D260 mm	消費電力	-W	重量	10.0 kg	<table border="1"> <tr><td>メーカー</td><td>Panasonic</td></tr> <tr><td>型番</td><td>WS-Q149-K</td></tr> <tr><td>外形寸法</td><td>φ200 × D510 mm</td></tr> <tr><td>消費電力</td><td>-W</td></tr> <tr><td>重量</td><td>5.0kg</td></tr> </table>		メーカー	Panasonic	型番	WS-Q149-K	外形寸法	φ200 × D510 mm	消費電力	-W	重量	5.0kg
メーカー	Panasonic																																																																																														
型番	ET-PKD130B																																																																																														
外形寸法	W379 × H56 × D400 mm																																																																																														
消費電力	-W																																																																																														
重量	3.0kg																																																																																														
メーカー	Panasonic																																																																																														
型番	ET-PKD120S																																																																																														
外形寸法	W258 × H80 × D286 mm																																																																																														
消費電力	-W																																																																																														
重量	3.0kg																																																																																														
メーカー	Panasonic																																																																																														
型番	WR-DX002																																																																																														
外形寸法	W480 × H250 × D88mm																																																																																														
消費電力	18W																																																																																														
重量	4.9kg																																																																																														
メーカー	TOA																																																																																														
型番	E-232																																																																																														
外形寸法	W483 × H46 × D311mm																																																																																														
消費電力	11W																																																																																														
重量	3.8kg																																																																																														
メーカー	Panasonic																																																																																														
型番	WP-DA204																																																																																														
外形寸法	W480 × H44 × D350 mm																																																																																														
消費電力	600 W																																																																																														
重量	6.0kg																																																																																														
メーカー	Panasonic																																																																																														
型番	WP-DA202																																																																																														
外形寸法	W480 × H44 × D350 mm																																																																																														
消費電力	300 W																																																																																														
重量	5.0 kg																																																																																														
メーカー	Panasonic																																																																																														
型番	WS-ARO80-K																																																																																														
外形寸法	W312 × H455 × D260 mm																																																																																														
消費電力	-W																																																																																														
重量	10.0 kg																																																																																														
メーカー	Panasonic																																																																																														
型番	WS-Q149-K																																																																																														
外形寸法	φ200 × D510 mm																																																																																														
消費電力	-W																																																																																														
重量	5.0kg																																																																																														
17	スピーカースタンド	2台	18	アンテナ	2台	19	ワイヤレスチューナー	1台	20	ワイヤレスマイク	4台	21	ヘッドセット	4台	22	マイク充電器	2台	23	電源制御装置	1台	24	機器収納ラック	1台																																																																								
																																																																																															
<table border="1"> <tr><td>メーカー</td><td>K&M</td></tr> <tr><td>型番</td><td>21450B</td></tr> <tr><td>外形寸法</td><td>φ140xH1050mm(折り畳み時)</td></tr> <tr><td>消費電力</td><td>-W</td></tr> <tr><td>重量</td><td>2.34kg</td></tr> </table>		メーカー	K&M	型番	21450B	外形寸法	φ140xH1050mm(折り畳み時)	消費電力	-W	重量	2.34kg	<table border="1"> <tr><td>メーカー</td><td>TOA</td></tr> <tr><td>型番</td><td>YW-560</td></tr> <tr><td>外形寸法</td><td>W208 × H208 × D42 mm</td></tr> <tr><td>消費電力</td><td>15mA (9V時)</td></tr> <tr><td>重量</td><td>720g</td></tr> </table>		メーカー	TOA	型番	YW-560	外形寸法	W208 × H208 × D42 mm	消費電力	15mA (9V時)	重量	720g	<table border="1"> <tr><td>メーカー</td><td>TOA</td></tr> <tr><td>型番</td><td>WT-D1804</td></tr> <tr><td>外形寸法</td><td>W420 × H45.9 × D300.7 mm</td></tr> <tr><td>消費電力</td><td>30W以下</td></tr> <tr><td>重量</td><td>4.5kg</td></tr> </table>		メーカー	TOA	型番	WT-D1804	外形寸法	W420 × H45.9 × D300.7 mm	消費電力	30W以下	重量	4.5kg	<table border="1"> <tr><td>メーカー</td><td>TOA</td></tr> <tr><td>型番</td><td>WM-D1300</td></tr> <tr><td>外形寸法</td><td>W62 × H102.5 × D22.6 mm</td></tr> <tr><td>消費電力</td><td>-W</td></tr> <tr><td>重量</td><td>110g(電池含む)</td></tr> </table>		メーカー	TOA	型番	WM-D1300	外形寸法	W62 × H102.5 × D22.6 mm	消費電力	-W	重量	110g(電池含む)	<table border="1"> <tr><td>メーカー</td><td>TOA</td></tr> <tr><td>型番</td><td>WH-1000</td></tr> <tr><td>外形寸法</td><td>W160mm(ヘッド部分)</td></tr> <tr><td>消費電力</td><td>-W</td></tr> <tr><td>重量</td><td>47g(コード含む)</td></tr> </table>		メーカー	TOA	型番	WH-1000	外形寸法	W160mm(ヘッド部分)	消費電力	-W	重量	47g(コード含む)	<table border="1"> <tr><td>メーカー</td><td>TOA</td></tr> <tr><td>型番</td><td>BC-2000</td></tr> <tr><td>外形寸法</td><td>W238 × H108.5 × D98mm</td></tr> <tr><td>消費電力</td><td>9W</td></tr> <tr><td>重量</td><td>550g(本体のみ)</td></tr> </table>		メーカー	TOA	型番	BC-2000	外形寸法	W238 × H108.5 × D98mm	消費電力	9W	重量	550g(本体のみ)	<table border="1"> <tr><td>メーカー</td><td>RAMSA</td></tr> <tr><td>型番</td><td>WU-L67</td></tr> <tr><td>外形寸法</td><td>W480 × H44 × D300 mm</td></tr> <tr><td>消費電力</td><td>10W</td></tr> <tr><td>重量</td><td>4.0kg</td></tr> </table>		メーカー	RAMSA	型番	WU-L67	外形寸法	W480 × H44 × D300 mm	消費電力	10W	重量	4.0kg	<table border="1"> <tr><td>メーカー</td><td>オーロラ</td></tr> <tr><td>型番</td><td>EIA-K24B</td></tr> <tr><td>外形寸法</td><td>W564 × H1202 × D601 mm</td></tr> <tr><td>消費電力</td><td>-W</td></tr> <tr><td>重量</td><td>36.5kg</td></tr> </table>		メーカー	オーロラ	型番	EIA-K24B	外形寸法	W564 × H1202 × D601 mm	消費電力	-W	重量	36.5kg
メーカー	K&M																																																																																														
型番	21450B																																																																																														
外形寸法	φ140xH1050mm(折り畳み時)																																																																																														
消費電力	-W																																																																																														
重量	2.34kg																																																																																														
メーカー	TOA																																																																																														
型番	YW-560																																																																																														
外形寸法	W208 × H208 × D42 mm																																																																																														
消費電力	15mA (9V時)																																																																																														
重量	720g																																																																																														
メーカー	TOA																																																																																														
型番	WT-D1804																																																																																														
外形寸法	W420 × H45.9 × D300.7 mm																																																																																														
消費電力	30W以下																																																																																														
重量	4.5kg																																																																																														
メーカー	TOA																																																																																														
型番	WM-D1300																																																																																														
外形寸法	W62 × H102.5 × D22.6 mm																																																																																														
消費電力	-W																																																																																														
重量	110g(電池含む)																																																																																														
メーカー	TOA																																																																																														
型番	WH-1000																																																																																														
外形寸法	W160mm(ヘッド部分)																																																																																														
消費電力	-W																																																																																														
重量	47g(コード含む)																																																																																														
メーカー	TOA																																																																																														
型番	BC-2000																																																																																														
外形寸法	W238 × H108.5 × D98mm																																																																																														
消費電力	9W																																																																																														
重量	550g(本体のみ)																																																																																														
メーカー	RAMSA																																																																																														
型番	WU-L67																																																																																														
外形寸法	W480 × H44 × D300 mm																																																																																														
消費電力	10W																																																																																														
重量	4.0kg																																																																																														
メーカー	オーロラ																																																																																														
型番	EIA-K24B																																																																																														
外形寸法	W564 × H1202 × D601 mm																																																																																														
消費電力	-W																																																																																														
重量	36.5kg																																																																																														
25	リモコン	3台	26	受信機外部ユニット	1台	27	セレクトスイッチ	1式	28	I/F	1台																																																																																				
																																																																																															
<table border="1"> <tr><td>メーカー</td><td>ダイセン電子工業</td></tr> <tr><td>型番</td><td>TC04ZBTM</td></tr> <tr><td>外形寸法</td><td>W45 × H97 × D14 mm</td></tr> <tr><td>消費電力</td><td>-W</td></tr> <tr><td>重量</td><td>34.7g</td></tr> </table>		メーカー	ダイセン電子工業	型番	TC04ZBTM	外形寸法	W45 × H97 × D14 mm	消費電力	-W	重量	34.7g	<table border="1"> <tr><td>メーカー</td><td>ダイセン電子工業</td></tr> <tr><td>型番</td><td>TC04ZBTM-C-RU</td></tr> <tr><td>外形寸法</td><td>W180.4 × H100.4 × D30mm</td></tr> <tr><td>消費電力</td><td>10W</td></tr> <tr><td>重量</td><td>100g</td></tr> </table>		メーカー	ダイセン電子工業	型番	TC04ZBTM-C-RU	外形寸法	W180.4 × H100.4 × D30mm	消費電力	10W	重量	100g	<table border="1"> <tr><td>メーカー</td><td>特注品</td></tr> <tr><td>型番</td><td></td></tr> <tr><td>外形寸法</td><td>W × H × D mm</td></tr> <tr><td>消費電力</td><td>-W</td></tr> <tr><td>重量</td><td>kg</td></tr> </table>		メーカー	特注品	型番		外形寸法	W × H × D mm	消費電力	-W	重量	kg	<table border="1"> <tr><td>メーカー</td><td>特注品</td></tr> <tr><td>型番</td><td></td></tr> <tr><td>外形寸法</td><td>W482 × H132 × D330 mm</td></tr> <tr><td>消費電力</td><td>300W</td></tr> <tr><td>重量</td><td>3.0kg</td></tr> </table>		メーカー	特注品	型番		外形寸法	W482 × H132 × D330 mm	消費電力	300W	重量	3.0kg																																																
メーカー	ダイセン電子工業																																																																																														
型番	TC04ZBTM																																																																																														
外形寸法	W45 × H97 × D14 mm																																																																																														
消費電力	-W																																																																																														
重量	34.7g																																																																																														
メーカー	ダイセン電子工業																																																																																														
型番	TC04ZBTM-C-RU																																																																																														
外形寸法	W180.4 × H100.4 × D30mm																																																																																														
消費電力	10W																																																																																														
重量	100g																																																																																														
メーカー	特注品																																																																																														
型番																																																																																															
外形寸法	W × H × D mm																																																																																														
消費電力	-W																																																																																														
重量	kg																																																																																														
メーカー	特注品																																																																																														
型番																																																																																															
外形寸法	W482 × H132 × D330 mm																																																																																														
消費電力	300W																																																																																														
重量	3.0kg																																																																																														

MEMO

勝連城址周辺整備事業 歴史文化施設展示制作業務

REVISION



TITLE

3.肝高ライブステージ

SUBJECTS

使用機器図

No.

AV02-3

DRAWN

DESIGNED

CHECKED

DATE

2020.12.16改訂

SCALE

NON

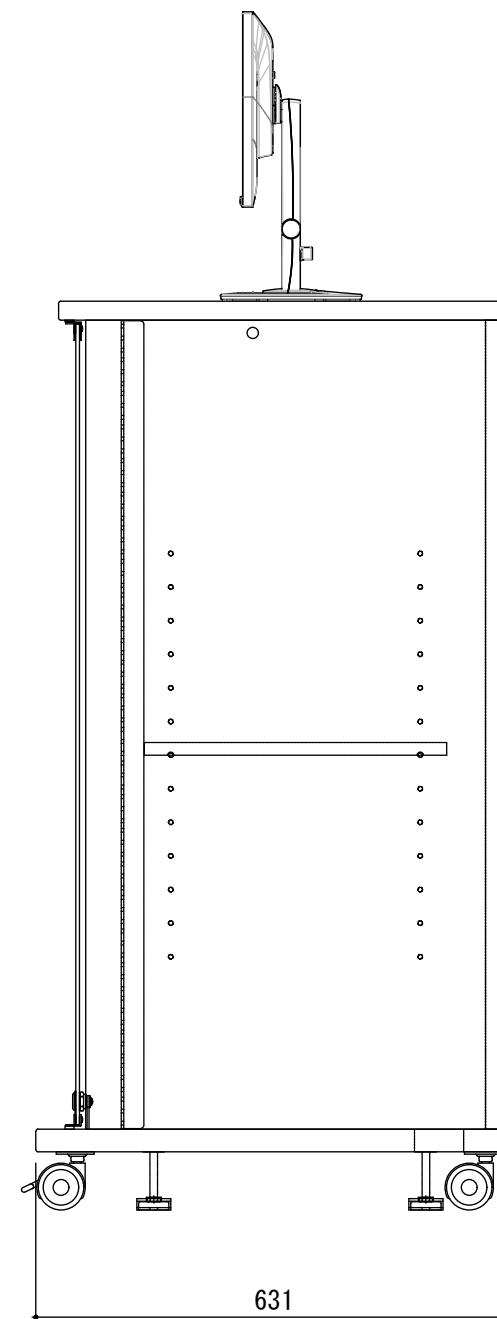
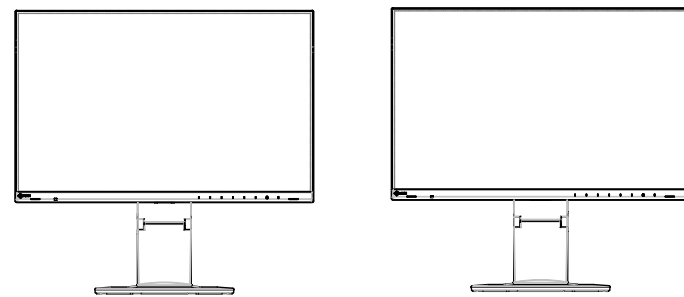
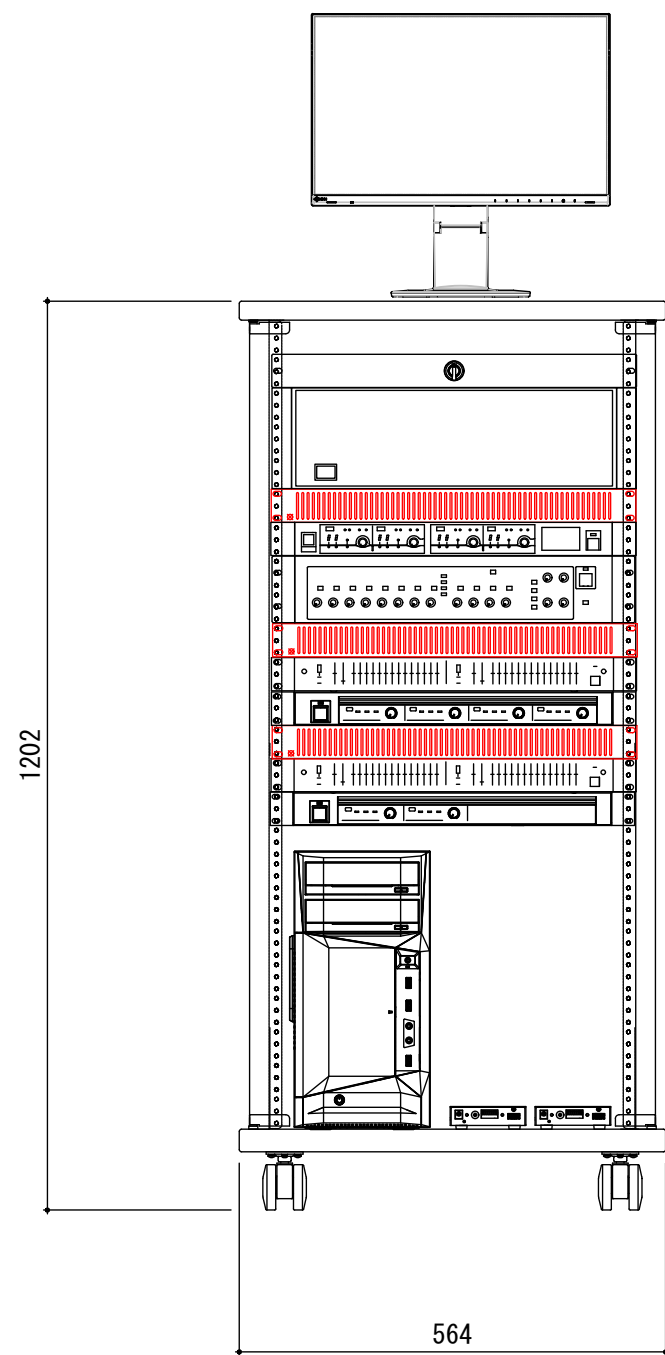

MEMO

勝連城址周辺整備事業 歴史文化施設展示制作業務

REVISION



TITLE

3.肝高ライブステージ

DRAWN

DESIGNED

CHECKED

SUBJECTS

ラック搭載図

DATE

2020.12.16改訂

SCALE

1/10(A3出力時)

No.

AV02-4

■ システム系統図

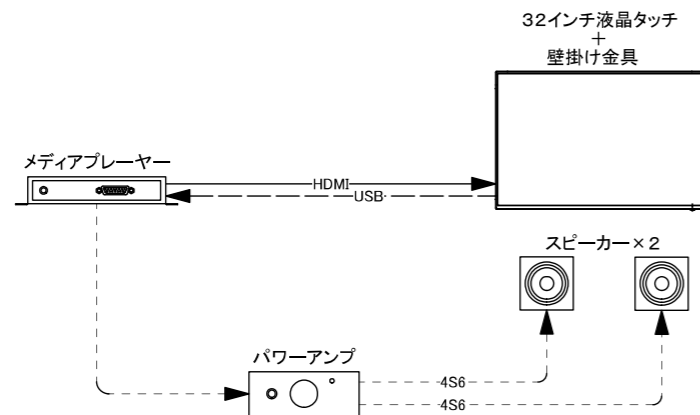





■ 使用機器一覧

No.	品名	仕様	メーカー及び型番	台数
1	メディアプレーヤー	対応ビデオコンテナ: Full HD 対応拡張子: .ts, .mpg, .vob, .mov, .mp4, .m2ts, .wmv	BrightSign HD1024	1台
2	SDXCカード	microSDXCカード class10 16GB 予備含む	Sandisk 16GB	2枚
3	32インチ液晶タッチ	感知方式: 赤外線走査方式 タッチ数: 最大10点 スピーカー: 5W×4	タッチパネルシステムズ ET3202L-2UWA-0-MT-ZB-GY-G	1台
4	壁掛け金具	垂直取付タイプ	ハヤミ工業 MH-651B	1台
5	パワーアンプ	最大出力: 15W+15W	Fostex Ap15d	1台
6	スピーカー	定格入力: 10W	LiveSound SM-1W60	2台

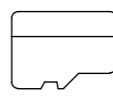
※ 機器に関しては、同等品以上とする。

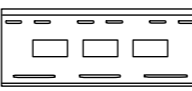
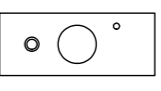
■ 機器図

1	メディアプレーヤー	1台	2	SDXCカード	2枚	3	32インチ液晶タッチ	1台																														
 <p>平成31年度納品済み</p> <table border="1"> <tr><td>メーカー</td><td>BrightSign</td></tr> <tr><td>型番</td><td>HD1024</td></tr> <tr><td>外形寸法</td><td>W159.9×H22×D144 mm</td></tr> <tr><td>消費電力</td><td>12V/1.5A</td></tr> <tr><td>重量</td><td>1.0g</td></tr> </table>			メーカー	BrightSign	型番	HD1024	外形寸法	W159.9×H22×D144 mm	消費電力	12V/1.5A	重量	1.0g	 <p>平成31年度納品済み</p> <table border="1"> <tr><td>メーカー</td><td>Sandisk</td></tr> <tr><td>型番</td><td>16GB</td></tr> <tr><td>外形寸法</td><td>W15×H11×t1 mm</td></tr> <tr><td>消費電力</td><td>-w</td></tr> <tr><td>重量</td><td>1g</td></tr> </table>			メーカー	Sandisk	型番	16GB	外形寸法	W15×H11×t1 mm	消費電力	-w	重量	1g	 <p>平成31年度納品済み</p> <table border="1"> <tr><td>メーカー</td><td>タッチパネルシステムズ</td></tr> <tr><td>型番</td><td>ET3202L-2UWA-0-MT-ZB-GY-G</td></tr> <tr><td>外形寸法</td><td>W763×H457×D51 mm</td></tr> <tr><td>消費電力</td><td>65w</td></tr> <tr><td>重量</td><td>13.0kg</td></tr> </table>			メーカー	タッチパネルシステムズ	型番	ET3202L-2UWA-0-MT-ZB-GY-G	外形寸法	W763×H457×D51 mm	消費電力	65w	重量	13.0kg
メーカー	BrightSign																																					
型番	HD1024																																					
外形寸法	W159.9×H22×D144 mm																																					
消費電力	12V/1.5A																																					
重量	1.0g																																					
メーカー	Sandisk																																					
型番	16GB																																					
外形寸法	W15×H11×t1 mm																																					
消費電力	-w																																					
重量	1g																																					
メーカー	タッチパネルシステムズ																																					
型番	ET3202L-2UWA-0-MT-ZB-GY-G																																					
外形寸法	W763×H457×D51 mm																																					
消費電力	65w																																					
重量	13.0kg																																					
4	壁掛け金具	1台	5	パワーアンプ	1台	6	スピーカー	2台																														
 <p>平成31年度納品済み</p> <table border="1"> <tr><td>メーカー</td><td>ハヤミ工業</td></tr> <tr><td>型番</td><td>LH-651B</td></tr> <tr><td>外形寸法</td><td>W500×H441×D71.5 mm</td></tr> <tr><td>消費電力</td><td>-w</td></tr> <tr><td>重量</td><td>5.0kg</td></tr> </table>			メーカー	ハヤミ工業	型番	LH-651B	外形寸法	W500×H441×D71.5 mm	消費電力	-w	重量	5.0kg	 <p>平成31年度納品済み</p> <table border="1"> <tr><td>メーカー</td><td>Fostex</td></tr> <tr><td>型番</td><td>Ap15d</td></tr> <tr><td>外形寸法</td><td>W110×H30×D75 mm</td></tr> <tr><td>消費電力</td><td>45W</td></tr> <tr><td>重量</td><td>250g</td></tr> </table>			メーカー	Fostex	型番	Ap15d	外形寸法	W110×H30×D75 mm	消費電力	45W	重量	250g	 <p>平成31年度納品済み</p> <table border="1"> <tr><td>メーカー</td><td>LiveSound</td></tr> <tr><td>型番</td><td>SM-1W60</td></tr> <tr><td>外形寸法</td><td>W60×H60×D60 mm</td></tr> <tr><td>消費電力</td><td>-W</td></tr> <tr><td>重量</td><td>25g</td></tr> </table>			メーカー	LiveSound	型番	SM-1W60	外形寸法	W60×H60×D60 mm	消費電力	-W	重量	25g
メーカー	ハヤミ工業																																					
型番	LH-651B																																					
外形寸法	W500×H441×D71.5 mm																																					
消費電力	-w																																					
重量	5.0kg																																					
メーカー	Fostex																																					
型番	Ap15d																																					
外形寸法	W110×H30×D75 mm																																					
消費電力	45W																																					
重量	250g																																					
メーカー	LiveSound																																					
型番	SM-1W60																																					
外形寸法	W60×H60×D60 mm																																					
消費電力	-W																																					
重量	25g																																					
<table border="1"> <tr><td>メーカー</td><td></td></tr> <tr><td>型番</td><td></td></tr> <tr><td>外形寸法</td><td></td></tr> <tr><td>消費電力</td><td></td></tr> <tr><td>重量</td><td></td></tr> </table>			メーカー		型番		外形寸法		消費電力		重量		<table border="1"> <tr><td>メーカー</td><td></td></tr> <tr><td>型番</td><td></td></tr> <tr><td>外形寸法</td><td></td></tr> <tr><td>消費電力</td><td></td></tr> <tr><td>重量</td><td></td></tr> </table>			メーカー		型番		外形寸法		消費電力		重量		<table border="1"> <tr><td>メーカー</td><td></td></tr> <tr><td>型番</td><td></td></tr> <tr><td>外形寸法</td><td></td></tr> <tr><td>消費電力</td><td></td></tr> <tr><td>重量</td><td></td></tr> </table>			メーカー		型番		外形寸法		消費電力		重量	
メーカー																																						
型番																																						
外形寸法																																						
消費電力																																						
重量																																						
メーカー																																						
型番																																						
外形寸法																																						
消費電力																																						
重量																																						
メーカー																																						
型番																																						
外形寸法																																						
消費電力																																						
重量																																						

■ システム系統図

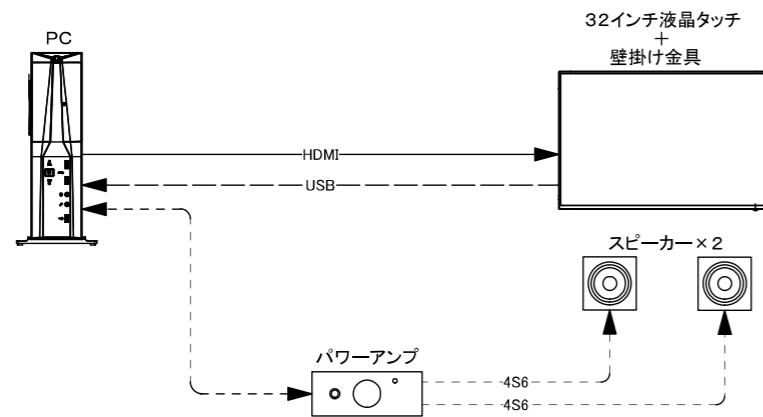





上記システム 2セット

■ 使用機器一覧

No.	品名	仕様	メーカー及び型番	台数
1	PC	CPU:インテルCore™i7-8700(3.2GHz) メモリ:16GB SSD:256GB OS:Windows10 IoT Enterprise 2019 LTSC	EPSON JM4800	2台
2	32インチ液晶タッチ	感知方式:赤外線走査方式 タッチ数:最大10点 スピーカー:5W×4	タッチパネルシステムズ ET3202L-2UWA-0-MT-ZB-GY-G	2台
3	壁掛け金具	垂直取付タイプ	ハヤミ工業 MH-651B	2台
4	パワーアンプ	最大出力:15W+15W	Fostex Ap15d	2台
5	スピーカー	定格入力:10W	LiveSound SM-1W60	4台

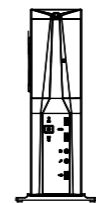
※ 機器に関しては、同等品以上とする。

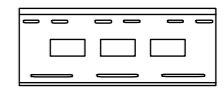
■ 機器図

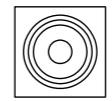
1	PC	2台	2	32インチ液晶タッチ	2台	3	壁掛け金具	2台																											
 <table border="1"> <tr><td>メーカー</td><td>EPSON</td></tr> <tr><td>型番</td><td>JM4800</td></tr> <tr><td>外形寸法</td><td>W98×H357×D395.5 mm</td></tr> <tr><td>消費電力</td><td>366W</td></tr> <tr><td>重量</td><td>7.0g</td></tr> </table>		メーカー	EPSON	型番	JM4800	外形寸法	W98×H357×D395.5 mm	消費電力	366W	重量	7.0g	 <p>平成31年度納品済み</p> <table border="1"> <tr><td>メーカー</td><td>タッチパネルシステムズ</td></tr> <tr><td>型番</td><td>ET3202L-2UWA-0-MT-ZB-GY-G</td></tr> <tr><td>外形寸法</td><td>W763×H457×D51 mm</td></tr> <tr><td>消費電力</td><td>65w</td></tr> <tr><td>重量</td><td>13.0kg</td></tr> </table>		メーカー	タッチパネルシステムズ	型番	ET3202L-2UWA-0-MT-ZB-GY-G	外形寸法	W763×H457×D51 mm	消費電力	65w	重量	13.0kg	 <p>平成31年度納品済み</p> <table border="1"> <tr><td>メーカー</td><td>ハヤミ工業</td></tr> <tr><td>型番</td><td>LH-651B</td></tr> <tr><td>外形寸法</td><td>W500×H441×D71.5 mm</td></tr> <tr><td>消費電力</td><td>- w</td></tr> <tr><td>重量</td><td>5.0kg</td></tr> </table>		メーカー	ハヤミ工業	型番	LH-651B	外形寸法	W500×H441×D71.5 mm	消費電力	- w	重量	5.0kg
メーカー	EPSON																																		
型番	JM4800																																		
外形寸法	W98×H357×D395.5 mm																																		
消費電力	366W																																		
重量	7.0g																																		
メーカー	タッチパネルシステムズ																																		
型番	ET3202L-2UWA-0-MT-ZB-GY-G																																		
外形寸法	W763×H457×D51 mm																																		
消費電力	65w																																		
重量	13.0kg																																		
メーカー	ハヤミ工業																																		
型番	LH-651B																																		
外形寸法	W500×H441×D71.5 mm																																		
消費電力	- w																																		
重量	5.0kg																																		
 <table border="1"> <tr><td>メーカー</td><td>Fostex</td></tr> <tr><td>型番</td><td>Ap15d</td></tr> <tr><td>外形寸法</td><td>W110×H30×D75 mm</td></tr> <tr><td>消費電力</td><td>45W</td></tr> <tr><td>重量</td><td>250g</td></tr> </table>		メーカー	Fostex	型番	Ap15d	外形寸法	W110×H30×D75 mm	消費電力	45W	重量	250g	 <table border="1"> <tr><td>メーカー</td><td>LiveSound</td></tr> <tr><td>型番</td><td>SM-1W60</td></tr> <tr><td>外形寸法</td><td>W60×H60×D60 mm</td></tr> <tr><td>消費電力</td><td>- W</td></tr> <tr><td>重量</td><td>25g</td></tr> </table>		メーカー	LiveSound	型番	SM-1W60	外形寸法	W60×H60×D60 mm	消費電力	- W	重量	25g												
メーカー	Fostex																																		
型番	Ap15d																																		
外形寸法	W110×H30×D75 mm																																		
消費電力	45W																																		
重量	250g																																		
メーカー	LiveSound																																		
型番	SM-1W60																																		
外形寸法	W60×H60×D60 mm																																		
消費電力	- W																																		
重量	25g																																		
<table border="1"> <tr><td>メーカー</td><td></td></tr> <tr><td>型番</td><td></td></tr> <tr><td>外形寸法</td><td></td></tr> <tr><td>消費電力</td><td></td></tr> <tr><td>重量</td><td></td></tr> </table>		メーカー		型番		外形寸法		消費電力		重量		<table border="1"> <tr><td>メーカー</td><td></td></tr> <tr><td>型番</td><td></td></tr> <tr><td>外形寸法</td><td></td></tr> <tr><td>消費電力</td><td></td></tr> <tr><td>重量</td><td></td></tr> </table>		メーカー		型番		外形寸法		消費電力		重量		<table border="1"> <tr><td>メーカー</td><td></td></tr> <tr><td>型番</td><td></td></tr> <tr><td>外形寸法</td><td></td></tr> <tr><td>消費電力</td><td></td></tr> <tr><td>重量</td><td></td></tr> </table>		メーカー		型番		外形寸法		消費電力		重量	
メーカー																																			
型番																																			
外形寸法																																			
消費電力																																			
重量																																			
メーカー																																			
型番																																			
外形寸法																																			
消費電力																																			
重量																																			
メーカー																																			
型番																																			
外形寸法																																			
消費電力																																			
重量																																			